



Biological Microscope ECLIPSE E200

ECLIPSE E200

Biological Microscope



Shedding New Light On **MICROSCOPY**

Features exceptionally bright and uniform LED illumination and Nikon's high-quality optics. Ergonomic and user-friendly design ensures years of comfortable and stable use.

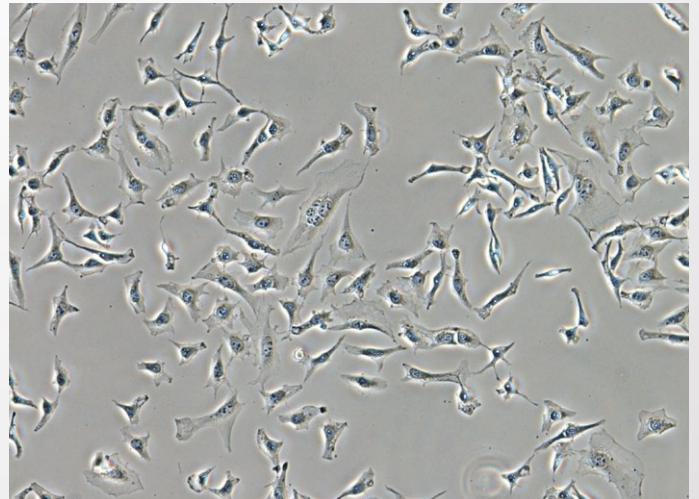
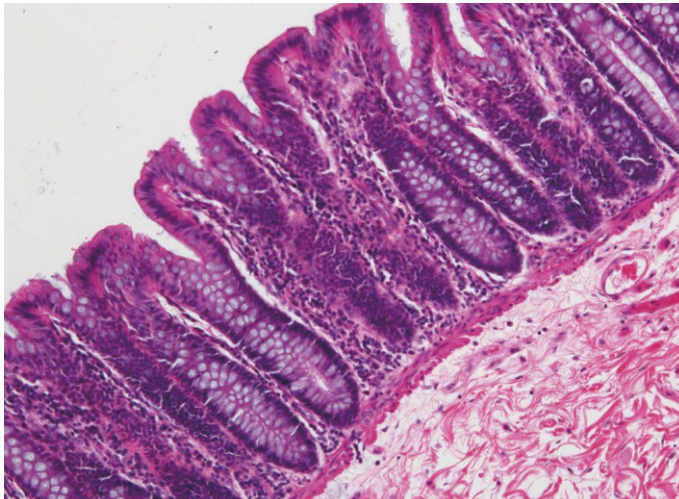

High-intensity LED Eco-illumination

The Eco-illumination provides enough brightness for both phase contrast observation and simple polarizing observation. With a fly-eye lens in the illumination system, uniform brightness is provided in the entire field of view. LEDs are environmentally friendly, consume less power than halogen lamps, and last approximately 60,000 hours, reducing costs and the need for frequent lamp replacement. The color temperature does not change when magnification is changed. A halogen illumination model is also available.

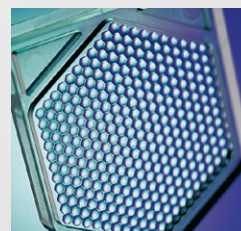

Fly-eye lens

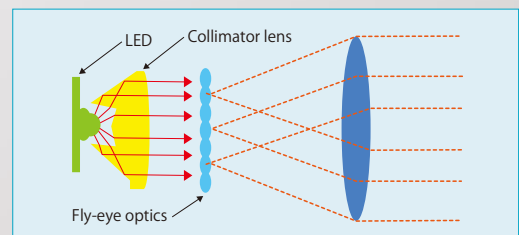
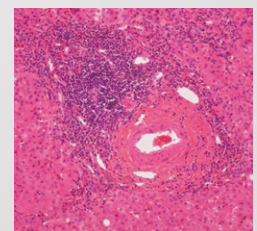

This compact small-sized clinical and laboratory microscope uses high-intensity LED illumination. The long-life LED illuminator is environmentally friendly as it reduces the need for frequent lamp replacement. A halogen illumination model is also available.

The ECLIPSE E200 uses Nikon's CFI60 optical system—highly-acclaimed infinity corrected optics used in Nikon research microscopes. The result is stunningly sharp and clear images with less chromatic aberration.

With the ECLIPSE E200, Nikon has designed a simple and easy-to-use system that reduces fatigue from use over long periods. With a robust structure and fungus-proof design, the ECLIPSE E200 offers high quality and accuracy that can be retained for years even in hot and humid environments.

The ECLIPSE E200 offers exceptional operability and durability, and high-quality images. It can be used for various purposes, such as educational, clinical laboratory use and basic research.



ECLIPSE E200-F (model with field diaphragm)

ECLIPSE E200

Superb infinity optics, plus ergonomic touches



CFI60 optical system

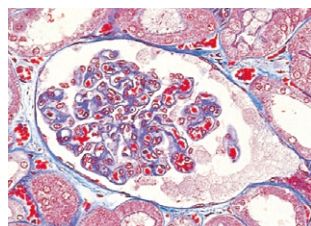

The CFI60 optical system combines Nikon's renowned CF optical design with infinity optics to overcome the limitations of the traditional infinity design. CFI60 optics provide longer working distances and higher NA's. These optics deliver startlingly clear images at any magnification because chromatic aberrations and curvature of field are both corrected over the entire field of view when the field number is 20 mm. Nikon developed dedicated CFI E Plan Achromat objectives exclusively for the E200. Also, you can use other higher-grade objectives available for the ECLIPSE series whenever your laboratory situation calls for it.

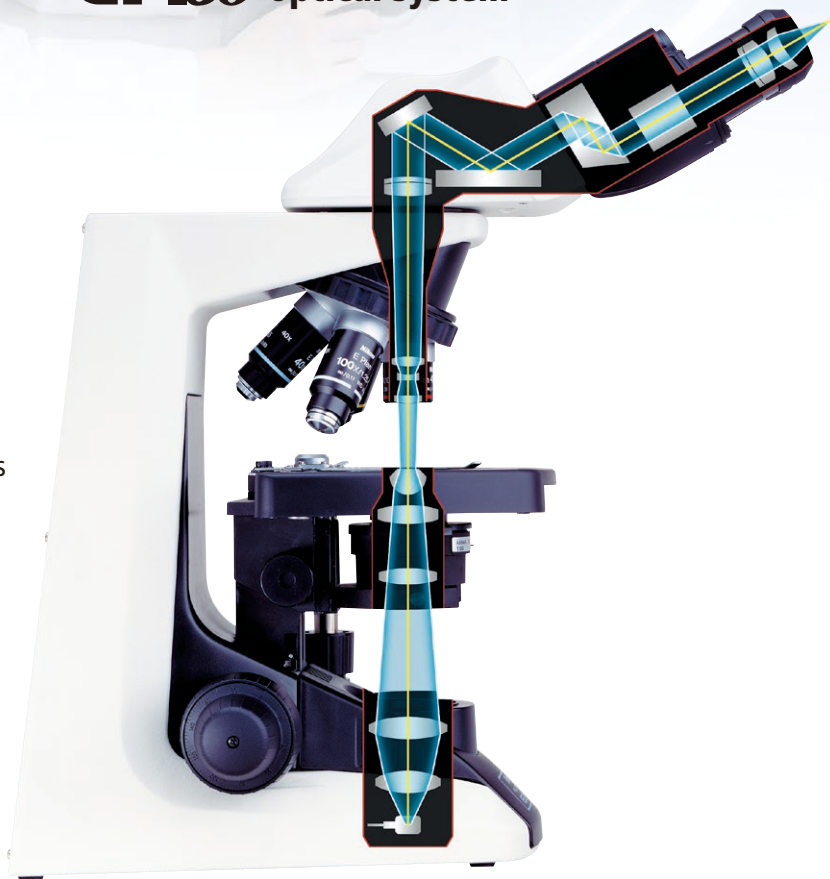

■ Fungus-proof design

Fungus is a formidable enemy of microscopes. It can quickly begin growing on the interior optical surfaces of the microscope and ruin performance. The ECLIPSE E200 is designed to prevent fungus forming on the surface of the main optical components. In tests, these optics were able to resist the growth of fungus for three consecutive years at an average temperature of 30 °C (86 °F) and 80 % humidity.

■ Ergonomic design equals comfortable operation

Comfort is ensured allowing long hours of use, thanks to Nikon's thoughtful ergonomic design. This is the same design incorporated into Nikon's other laboratory and research-grade ECLIPSE series microscopes.

For example, the focus knob and the stage handle are located equidistant from the operator, permitting one-handed operation in a natural posture without twisting the shoulders. Because these controls are low positioned, you can operate the microscope while resting your arms comfortably on the desk. Moreover, the low-profile stage makes exchange of specimen slides easy, while the low inclination angle tube provides comfortable viewing.

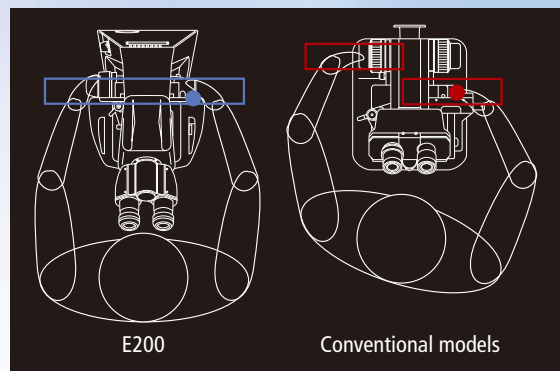

Comparison of the positions of the stage handle and focus control knob

■ Ergonomic binocular tube

With this option, users can adjust not only the tube tilt angle, but the eyepiece length to suit their build, eliminating discomfort and strain during long hours of observation. A camera can be attached using the DSC port for ergonomic binocular tube.

- *Use of this accessory in combination with other equipment may produce darker images around the periphery.
- *Must be attached directly to the main body.



View angle is adjustable by 10° to 30°.



Eyepiece length can be extended by up to 40 mm.



E200 configured with an ergonomic binocular tube.

■ Eye-level riser

Up to two eye-level risers can be mounted to raise the height of the eyepoint—25 mm each for a total of 50 mm.

■ Robust, vibration resistant construction

One-piece construction from arm to base, a stage design where its up/down mechanism is located in the base, plus a wide footprint of 188.5 mm across the back all provide greater rigidity and resistance to vibrations, contributing to superior images.

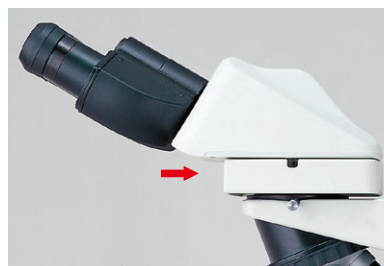

Design ideas that ensure superb optical quality and increased ease of use

CFI60 objectives

Nikon's exclusive CFI60 objectives provide numerous benefits: longer working distances, high numerical apertures, flat images over the entire field of view with virtually no curvature of field when the field number is 20 mm. To match your laboratory requirements, the E200 provides a wide selection of objectives to choose from. These include the CFI E Plan Achromat objectives developed for the E200 or other higher-grade ECLIPSE series objectives.



CFI E Plan Achromat objectives

Tube

The Siedentopf-type tube is inclined at 30° to ensure comfortable viewing in a natural posture. Designed for use by operators with different builds, this tube has a narrow minimum interpupillary distance of 47 mm, while the eyepoint height can be raised 34 mm when interpupillary distance is 64 mm by simply swinging the front part of the tube up 180°. For extremely tall users, eye-level risers are available to customize the microscope.

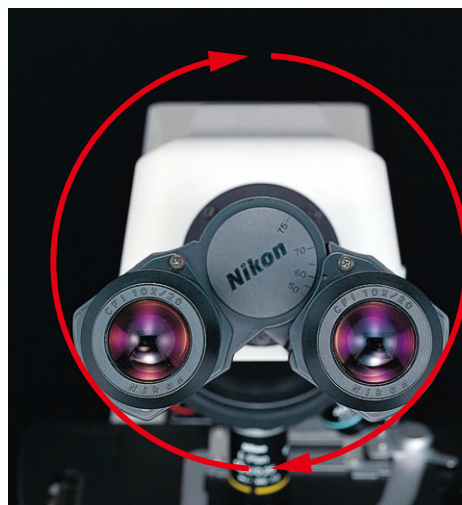

Low position



High position



E2-TB Binocular Tube



E2-TF Trinocular Tube

*Eyepieces are optional.

Eyepieces

The E200's eyepieces feature a wider field of view for a microscope of this class and are available in 10X (F.O.V. 20) and 15X (F.O.V. 12) types. These eyepieces also feature built-in diopter adjustment that allows the operator to adjust diopters separately for the right and left easily. In addition, these eyepieces accept measuring reticles that will always be in sharp focus with the specimen. Moreover, they can be locked preventing theft and eliminating the possibility of damage during transit.



F.O.V. 20 (E200)

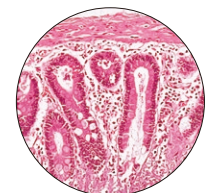

F.O.V. 18 (conventional model)

Refocusing stage

Nikon has created a unique innovation. The Refocusing Stage eliminates the need to refocus the image manually, making specimen handling safer and easier. In this unique design, the stage can be instantly dropped by pushing it down to exchange specimens or oil the slide, then returns to the original position as soon as the hand is removed. The wide stage surface can accommodate two slide glasses at the same time.

In addition, this stage has an array of features including:

- Increased resistance to vibrations due to the design of the in-base focus mechanism
- Low-profile design that creates more space around the objective for increased freedom in specimen handling and easier operation
- A belt-drive mechanism to eliminate the projection of the rack at the edge of the stage for better ergonomics and smoother movement
- Removable specimen holder for fast hand scanning of slides
- Improved XY cross travel, providing the comfort and feel similar to Nikon's higher grade ECLIPSE series microscopes



Wide stage surface with no rack sticking out of the stage

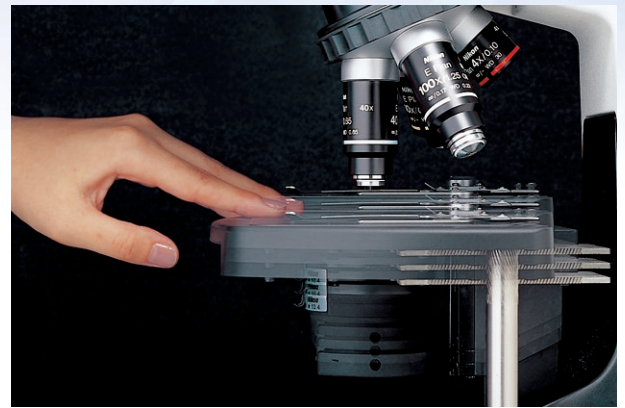

Upper limit stopper

When using short-working-distance objectives such as 40X or greater, you can set the upper limit of the stage movement, so that the objective doesn't hit the specimen slide, protecting both from damage. Thanks to this feature, even novices or operators who need to change slides often can perform their job easily and quickly. The limit height can be set in two levels using a stopper bolt—either at the standard position or 2 mm lower. This feature is very useful except when extraordinarily thick specimens are used.

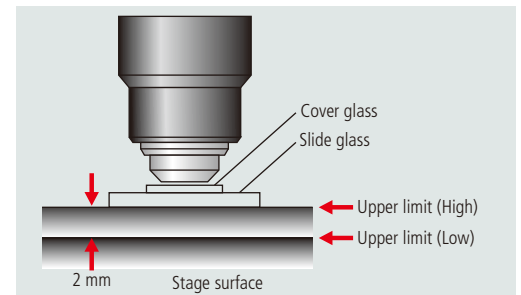

Revolving nosepiece

A reversed-type nosepiece creates more space at the front of the stage, making handling of specimen slides fast and easy. In addition, the CF160 optical design eliminates extra optical elements in the nosepiece for enhanced image sharpness. Another advantage of CF160 objectives is that their increased objective lengths and longer working distances provide more working space around the nosepiece.



Condenser

Although the stage is low-positioned for comfort, there is ample space around the condenser for easy access. The condenser also features an aperture diaphragm that comes complete with position guide markings for respective E Plan objectives to make operation quick and easy.



Safe and easy halogen lamp replacement

The E200 comes with a halogen illumination model in addition to a LED illumination model. The lamp is easily replaced by simply opening the lens unit cover and inserting a new one.



Field diaphragm model available

The E200-F has a built-in field diaphragm that allows the use of Koehler illumination. It features a field lens unit with a field diaphragm that has position guide markings for respective objectives to allow easy setting of optimal apertures.



Field diaphragm with position guide markings



E200-F

A wealth of accessories to broaden the range of microscopic applications

Epi-fluorescence microscopy (LED illumination)

The E200-dedicated epi-fluorescence attachment, equipped with an LED light source with a minimum lifespan of 10,000 hours, eliminates the need for lamp centering and warming-up time, thus enabling observation immediately after it is switched on.

- The light intensity can be controlled from a remote controller dial.
- Up to two LED units from four excitation wavelengths (385nm/470nm/525nm/625nm) can be mounted on the lamphouse, while up to two filter cubes can be mounted on the epi-fluorescence attachment.
- Eliminating the need of an external transformer facilitates saving space and easy transportation.

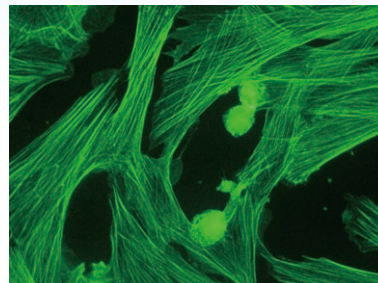

Epi-fluorescence accessories

Phase contrast microscopy/darkfield microscopy

Phase contrast observation at 10X, 20X and 40X is possible with a single phase annulus slider. The aperture diaphragm automatically opens when the slider is inserted into the condenser. A phase contrast slider for 100X observation is also available.

Darkfield observation up to 40X is possible with the E2 Phase Contrast Condenser.



- ① GIF Filter
- ② Centering Telescope
- ③ E2 Phase Contrast Condenser
- ④ Phase Contrast Slider 10X-40X
- ⑤ Phase Contrast Slider 100X
- ⑥ Darkfield Slider

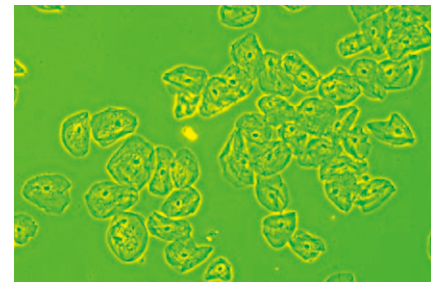

CFI Achromat DL objectives for phase contrast

Simple polarizing microscopy

This method is ideal for observing amyloid and crystals. To set up, install the polarizer over the field lens and the analyzer.



Simple polarizing accessories

Brightfield microscopy

A dedicated Abbe condenser is available for brightfield observation. A blue filter enabling natural color observation can be attached to the condenser.



E2 Abbe Condenser

Teaching heads

Face-to-face and side-by-side teaching heads are available.



Microscope camera

A C-mount camera can be mounted on the E200 via a trinocular tube* or DSC port-equipped ergonomic binocular tube. The DS-Fi3 is a high-definition color camera equipped with a 5.9 megapixel CMOS image sensor that enables the acquisition of images up to 2880 x 2048 pixels. Its high-speed data readout, superior color reproduction and high quantum efficiency are optimal for acquiring various types of images such as brightfield, phase contrast and fluorescence images. Simplified camera settings and image acquisition are possible via a tablet PC using NIS-Elements L imaging software.

*When using a 4X objective, use a diffusion plate to prevent unevenly illuminated images.



Drawing tube

Allows accurate sketching of the image being observed



Plastic storage case

The rugged, lightweight storage case is handy for transporting and storing the E200.



Object marker

Allows the point of interest within a specimen to be marked with ink

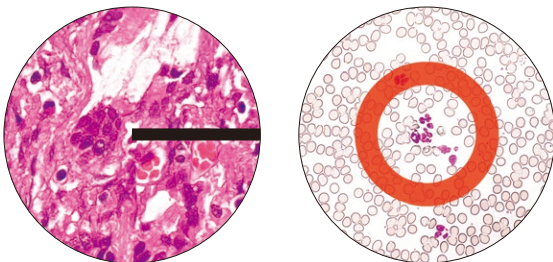

ND filter for objectives (ND3)

When this filter is used in combination with a 4X or 10X objective, image brightness can be adjusted to nearly equal to that of a 40X objective.

System diagram

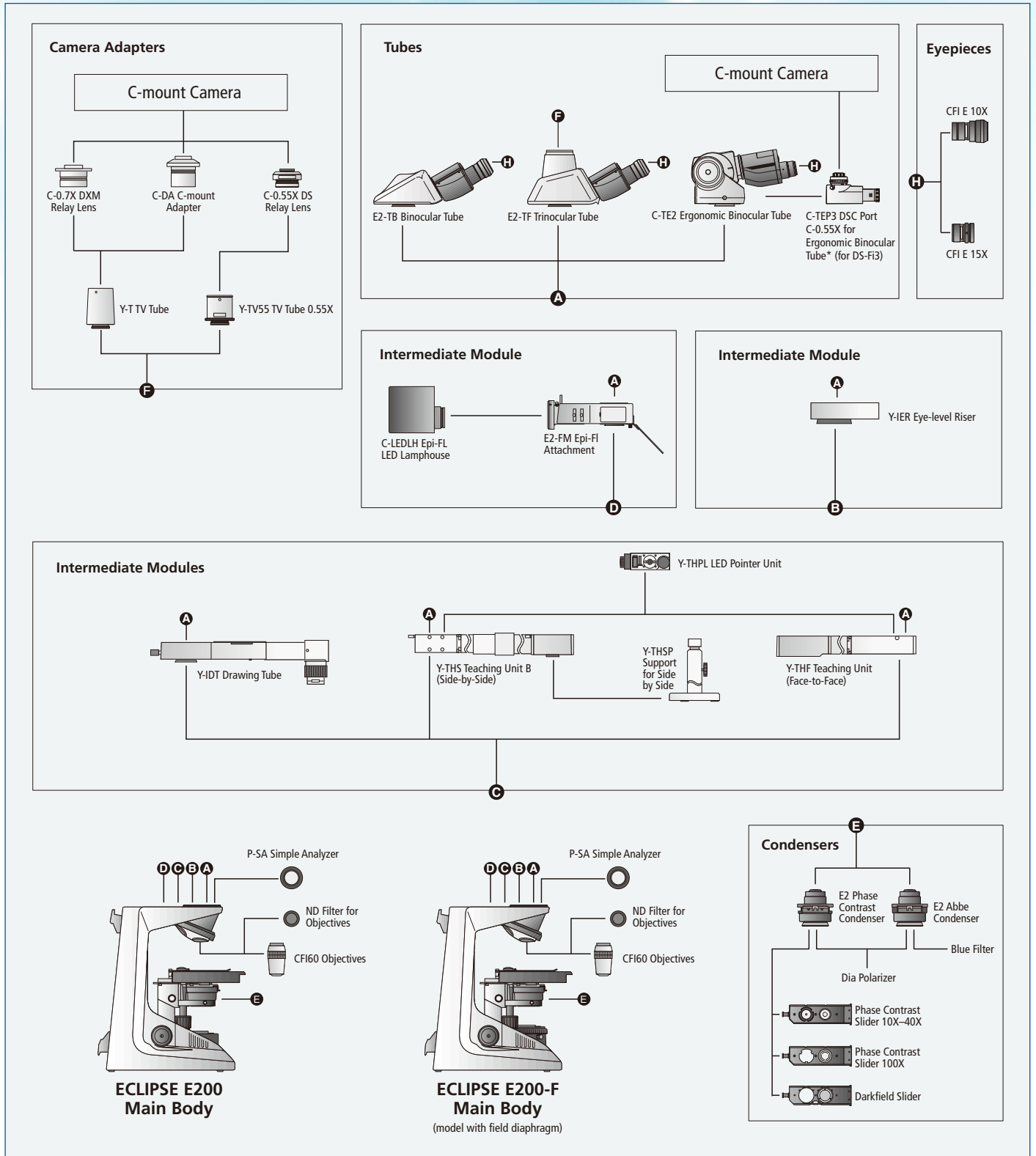

The E200 and E200-F are available in both LED-illuminated and halogen-illuminated models.
 * C-TEP2 DSC Port for Ergonomic Binocular Tube with 0.7X relay lens is also available

Specifications

Main body	
Optical system	CFI60 Infinity Optical System, Parfocal distance: 60 mm
Illumination	LED model: High luminescent white LED illuminator (Eco-illumination), Approx. 60,000 hours lifetime, Compliant multi-voltage (100 V-240 V) Halogen model: 6V20W/6V30W halogen lamp, Compliant multi-voltage (100 V-240 V)
Fungus-proof eyepieces (F.O.V., mm)	With diopter adjustment • CFI E 10X (20) • CFI E 15X (12)
Focusing	Coaxial coarse/fine focusing, Right: fine, Left: coarse/fine, Focusing stroke: 26.5 mm, Coarse: 37.7 mm/rotation, Fine: 0.2 mm/rotation, Coarse motion torque adjustable, Refocusing function (includes self-restoring stage height after pushing down stage)
Fungus-proof tubes	<ul style="list-style-type: none"> • E2-TB Binocular Tube, Inclination: 30°, Pupillary distance: 47 - 75 mm, With eyepiece fixing clamp • E2-TF Trinocular Tube, Eyepiece/Port: 100/0, 0/100, 360° rotatable, Inclination: 30°, Pupillary distance: 47 - 75 mm, With eyepiece fixing clamp • C-TE2 Ergonomic Binocular Tube, Eyepiece/Port: 100/0, 50/50 via optional C-TEP2 DSC Port or C-TEP3 DSC port for ergonomic binocular tube, Inclination: 10°–30°, Extension: up to 40 mm, Pupillary distance: 50 - 75 mm, With eyepiece fixing clamp
Nosepieces	Reversed-type quadruple nosepiece (within main body)
Stages	Rectangular stage (within main body), with specimen holder, Cross travel: 78 (X) x 54 (Y) mm, Stage size: 222 (W) x 144 (D) mm
Fungus-proof objectives (NA / W.D., mm)	<ul style="list-style-type: none"> • CFI E Plan Achromat 4X (0.10 / 30.00) • CFI E Plan Achromat 10X (0.25 / 7.00) • CFI E Plan Achromat 40X (0.65 / 0.65) • CFI E Plan Achromat 100X Oil (1.25 / 0.23) CFI Achromat DL and other higher-grade CFI60 objectives can be used.
Condensers	<ul style="list-style-type: none"> • E2 Abbe Condenser NA 1.25, Aperture diaphragm with position guide markings for respective CFI E Plan objectives • E2 Phase Contrast Condenser NA 1.25, Aperture diaphragm with position guide markings for respective CFI Achromat DL objectives
Observation methods*1	Brightfield, Epi-fluorescence, Darkfield, Phase contrast, Simple polarizing
Intermediate attachment**2	<ul style="list-style-type: none"> • E2-FM Epi-fluorescence Attachment, 2 filter cubes mountable, LED illumination (385/470/525/625 nm) • Y-THS Teaching Unit B (Side-by-Side) • Y-THF Teaching Unit (Face-to-Face) • Y-IDT Drawing Tube • Y-IER Eye-level Riser
Power consumption (max.)	Normal value: 3 W (LED model), 41 W (halogen model)
Weight (approx.)	7.3 kg (Binocular standard set)

*1 Observations except brightfield require optional accessories. *2 Maximum intermediate space 50 mm

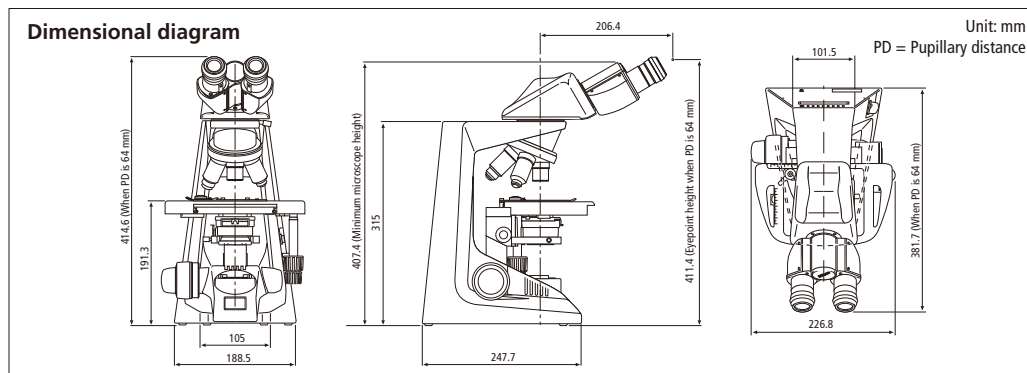

Specifications and equipment are subject to change without any notice or obligation on the part of the manufacturer. June 2019 ©2000-19 NIKON CORPORATION

	WARNING	TO ENSURE CORRECT USAGE, READ THE CORRESPONDING MANUALS CAREFULLY BEFORE USING YOUR EQUIPMENT.
--	----------------	--

Monitor images are simulated.

Company names and product names appearing in this brochure are their registered trademarks or trademarks.

N.B. Export of the products* in this brochure is controlled under the Japanese Foreign Exchange and Foreign Trade Law.

Appropriate export procedure shall be required in case of export from Japan.

*Products: Hardware and its technical information (including software)



NIKON CORPORATION

Shinagawa Intercity Tower C, 2-15-3, Konan, Minato-ku, Tokyo 108-6290, Japan
phone: +81-3-6433-3705 fax: +81-3-6433-3785
<https://www.healthcare.nikon.com/>

ISO 14001 Certified
for NIKON CORPORATION

NIKON INSTRUMENTS INC.

1300 Walt Whitman Road, Melville, N.Y. 11747-3064, U.S.A.
phone: +1-631-547-8500; +1-800-52-NIKON (within the U.S.A. only)
fax: +1-631-547-0306
<https://www.microscope.healthcare.nikon.com/>

NIKON INSTRUMENTS EUROPE B.V.

Tripolis 100, Burgervveeshuispad 101, 1076 ER Amsterdam, The Netherlands
phone: +31-20-7099-000 fax: +31-20-7099-298
https://www.microscope.healthcare.nikon.com/en_EU/

NIKON INSTRUMENTS (SHANGHAI) CO., LTD.

CHINA phone: +86-21-6841-2050 fax: +86-21-6841-2060
(Beijing branch) phone: +86-10-5831-2028 fax: +86-10-5831-2026
(Guangzhou branch) phone: +86-20-3882-0550 fax: +86-20-3882-0580

NIKON CANADA INC.

CANADA phone: +1-905-602-9676 fax: +1-905-602-9953

NIKON FRANCE S.A.S.

FRANCE phone: +33-1-4516-45-16 fax: +33-1-4516-45-55

NIKON GMBH

GERMANY phone: +49-211-941-42-20 fax: +49-211-941-43-22

NIKON INSTRUMENTS S.p.A.

ITALY phone: +39-55-300-96-01 fax: +39-55-30-09-93

NIKON GMBH SWITZERLAND

SWITZERLAND phone: +41-43-277-28-67 fax: +41-43-277-28-61

NIKON UK LTD.

UNITED KINGDOM phone: +44-208-247-1717 fax: +44-208-541-4584

NIKON CEE GMBH

AUSTRIA phone: +43-1-972-6111 fax: +43-1-972-611-140

NIKON SINGAPORE PTE LTD

SINGAPORE phone: +65-6559-3651 fax: +65-6559-3668

NIKON INSTRUMENTS KOREA CO., LTD.

KOREA phone: +82-2-2186-8400 fax: +82-2-555-4415